

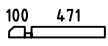

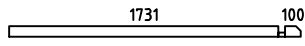

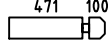

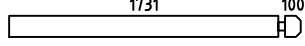



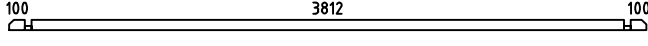
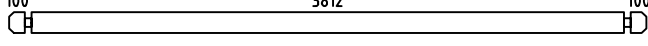
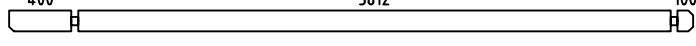
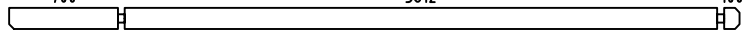
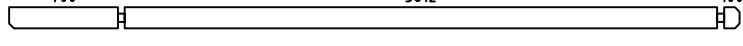
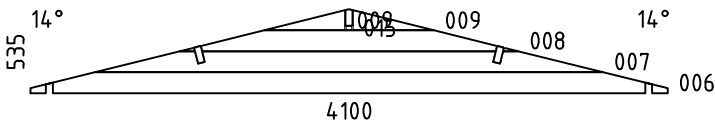
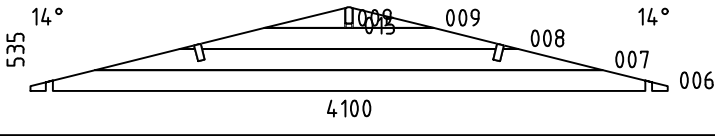
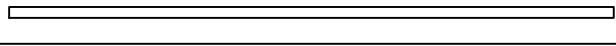
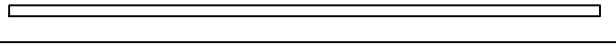
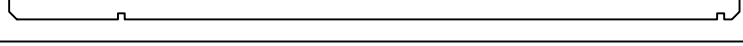
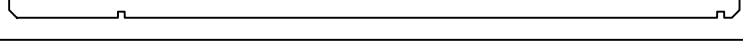
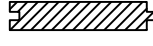

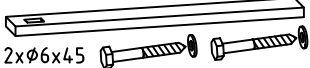

Artur 44

Pos	Specification-Spezifikation-Specificatie-Nomenclature-Elementi-Especificacion Artur 44	Qty	Profile (mm)	Lenght (mm)
001		1	44x68	615
002		1	44x68	1875
003		22	44x135	615
004		6	44x135	1875
005		8	44x135	480
010		1	44x68	4100
011		40	44x135	4100
012		2	44x135	4400
013		1	44x135	4700
014		1	44x135	4700
W1-1		1		
W2-1		1		
F1	FOUNDATION-FUNDAMENT-FONDATION-FONDAZIONE-VIGAS DE CIMENTACIÓN 	2	44x70	3890
F2	FOUNDATION-FUNDAMENT-FONDATION-FONDAZIONE-VIGAS DE CIMENTACIÓN 	10	44x70	3802
PL1	PURLIN-DAKBALK-DACHPFETTE-PANNE-ARCARECCIO-CORREA 	2	44x144	4700
PL2	PURLIN-DAKBALK-DACHPFETTE-PANNE-ARCARECCIO-CORREA 	1	44x144	4700
F-1	Floor board-Fussbodenbrett-Vloerplank-Lame de plancher-Tavola pavimento-Tabla de suelo 	44+1 34+1	88x18 114x18	3802
R-1	Roof board-Dachbrett-Dakplank-Volige-Tavola tetto-Tabla de tejado 	108+2 83+1	88x18 114x18	2265
FLB-1	Floor beading 2000-Fussbodenleiste-Plinten-Moulure de finition-Listello pavimento-Liston de suelo 	8	18x40	16rmt.
GB-1	Gable board 95-Giebelblende-Gevelplank-Planche de rive-Tavola di bordo-Tabla de borde 	2	18x95	4700
GB-1	Gable board 120-Giebelblende-Gevelplank-Planche de rive-Tavola di bordo-Tabla de borde 	4	18x120	2305
Model	Artur 44	Material	Page 1/2	

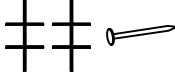
Pos	Specification-Spezifikation-Specificatie-Nomenclature-Elementi-Especificacion Artur 44	Qty	Profile (mm)	Lenght (mm)
RL-1	Roofing lath 3000-Giebelleiste-Gevellijst-Latte de rive-Listello di bordo-Listones de borde 	8	18x40	24rmt.
SS-1	Storm slat kit-Sturmleiste satz-Stormanker set-Kit de latte anti tempête-Kit listello di tempesta-Kit liston anti tormenta 	4	18x40	2000
D	Diamond 	2		
	Double door kit ISO-Doppeltür satz-Dubbele deur set-Kit double porte-Kit porta-Kit para puerta 	1		
	Nail 1.6x30-Nagel-Spijker-Clou-Chiodo-Clavo 	20	1.6x30	
	Nail 1.8x40-Nagel-Spijker-Clou-Chiodo-Clavo 	750	1.8x40	
S4x60	Screw 4x60-Schraube-Schroef-Vis-Vite-Tornillo 	80	4x60	
S6x120	Screw 6x120-Schraube-Schroef-Vis-Vite-Tornillo 	40	6x120	
	Window handle set-Fenstergriff-Raamgreep-Ferrure de fenêtre-Ferramenta finestra-Manilla ventana 	1		
	WINDOW 770x1050 W0-6DK 770x1050-44 L ISO 	1		
	DOOR 1600x1900 DD06-6 F 1600x1900-44 ISO 	1		
Model	Artur 44	Material	Page	2/2

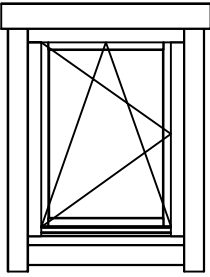
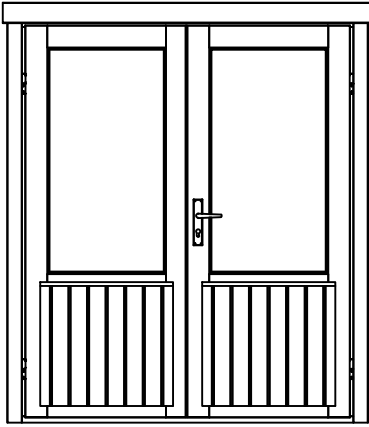
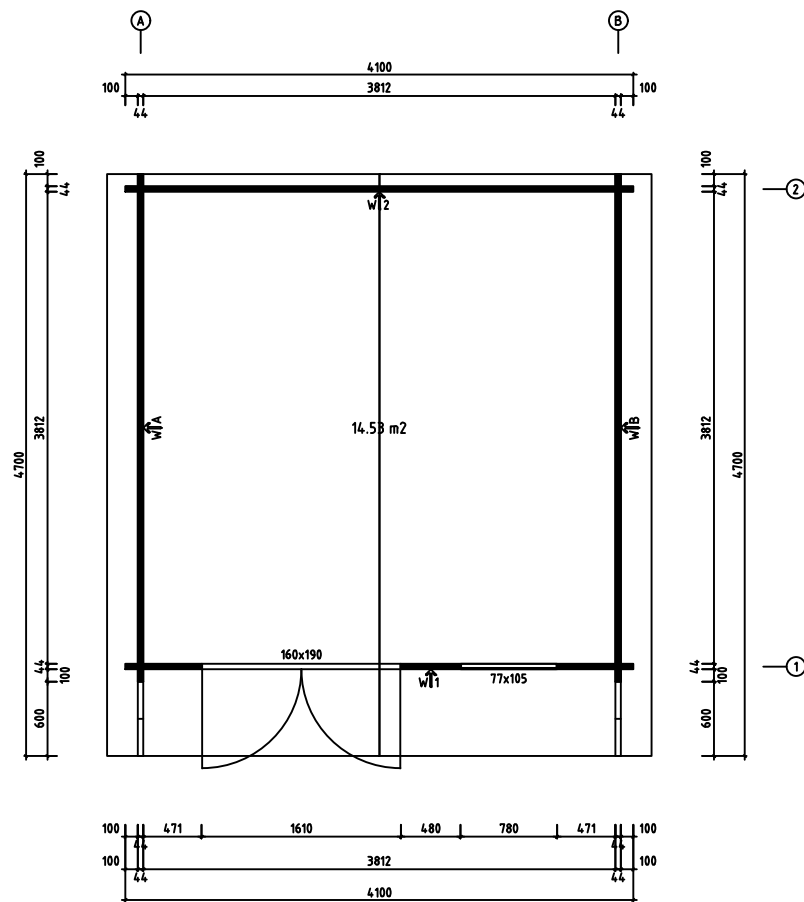

0 0.5m 1m 2m	
Model	Artur 4.4
Drawng	PLAN
Material	4.4 x 135
File	Artur 4.4.dwg
Page	
Scale	1:30
Date	16.03.2026
Drawn by	

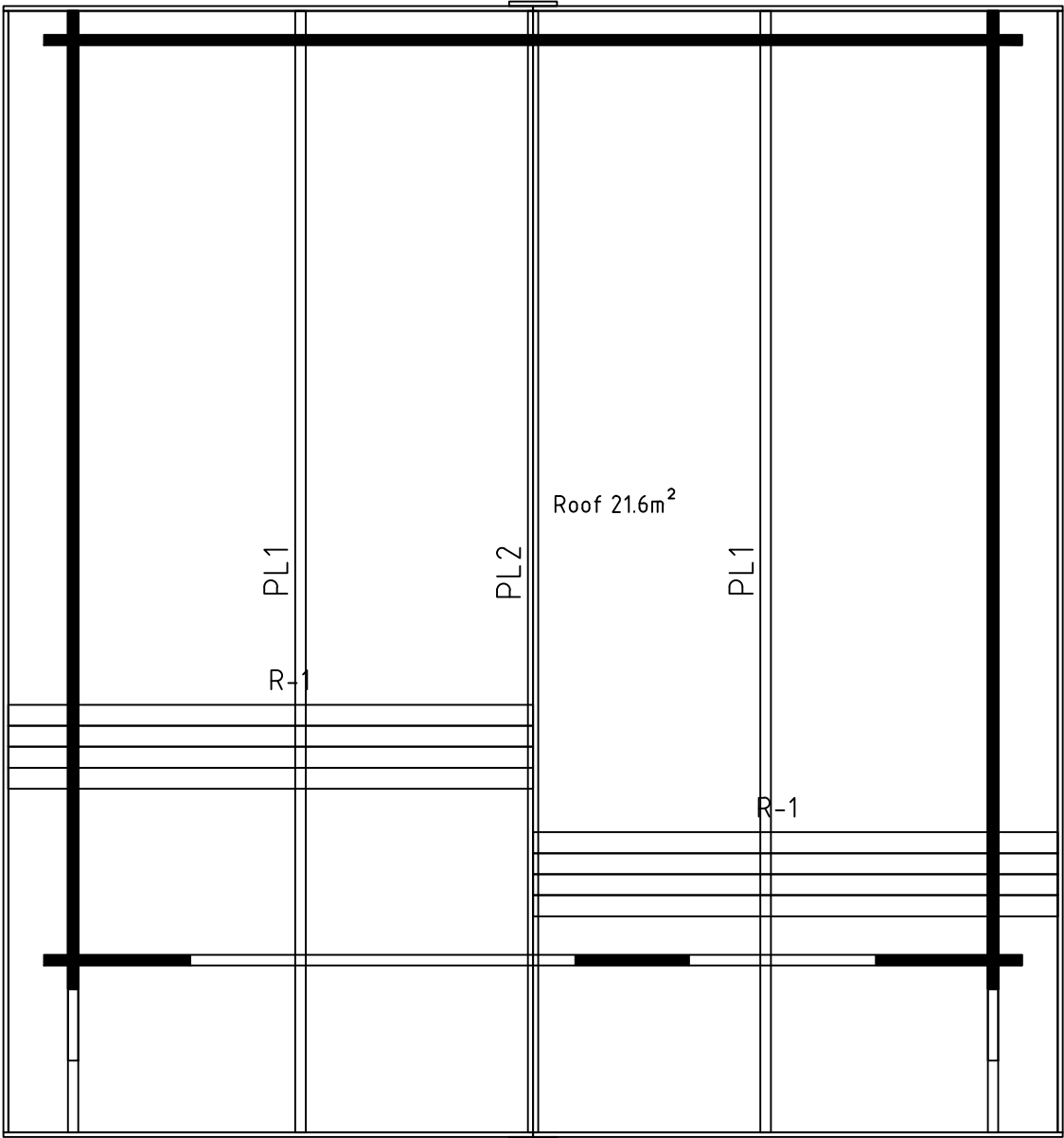

Roof 21.6m<sup>2</sup>

PL1

PL2

PL1

R-1

R-1

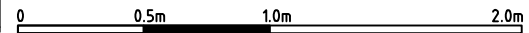

Model	Artur 44	Page
Drawing	ROOF	Scale 1:30
Material	44x135	Date 16.03.2026
File	Artur 44.dwg	Drawn by

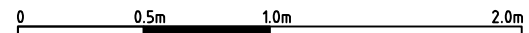
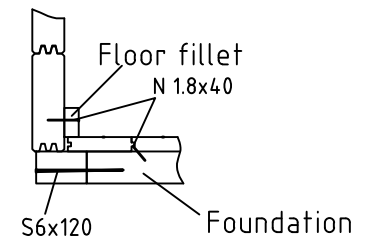
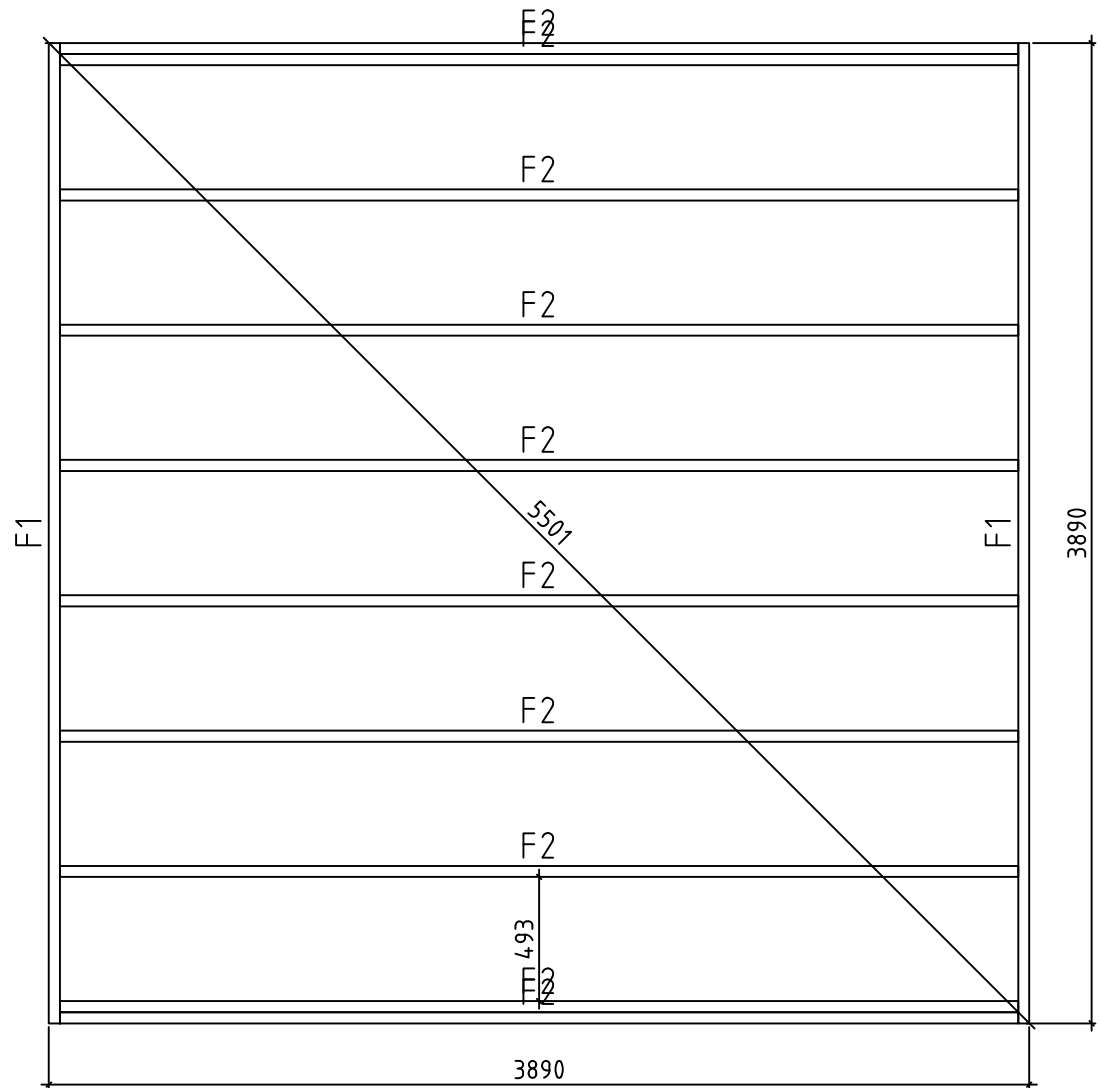

Model	Artur 44	Page	
Drawing	FOUNDATION	Scale	1:30
Material	44x135	Date	16.03.2026
File	Artur 44.dwg	Drawn by	



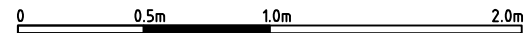
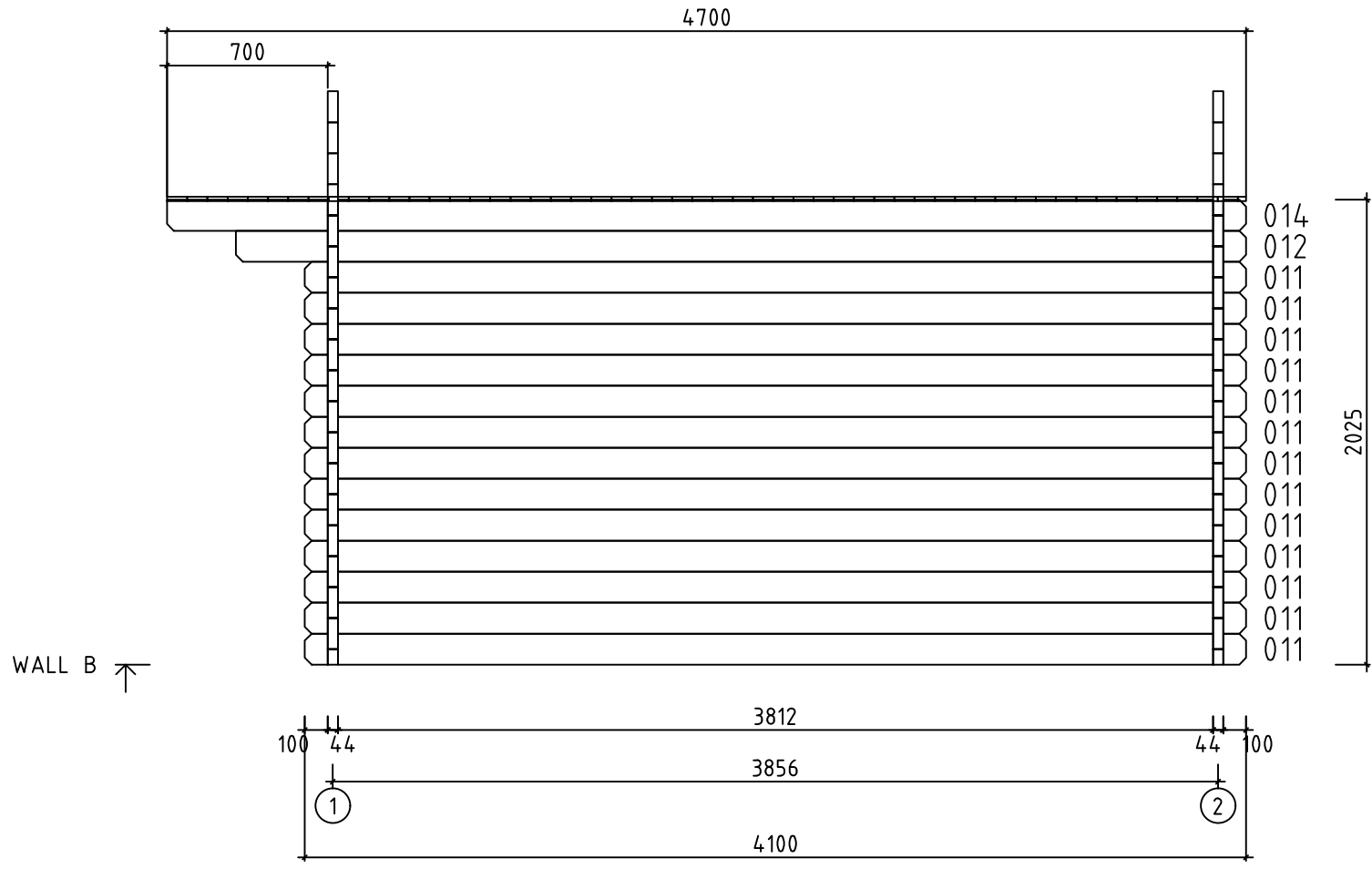

Model	Artur 44	Page	4
Drawing	WALL B	Scale	1:30
Material	4.4x13.5	Date	16.03.2026
File	Artur 44.dwg	Drawn by	



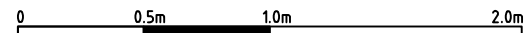
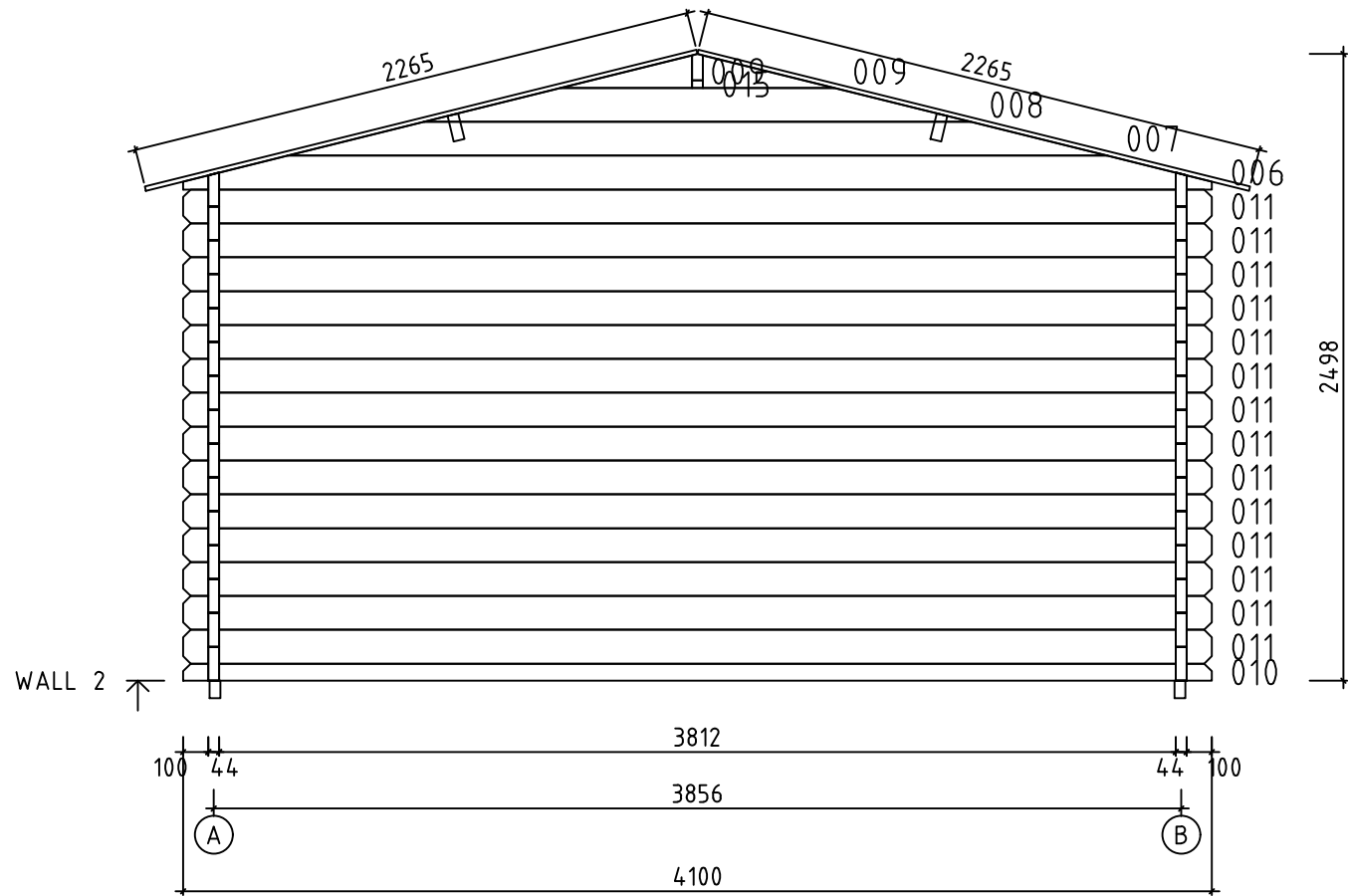

Model	Artur 44	Page	6
Drawing	WALL 2	Scale	1:30
Material	4.4x13.5	Date	16.03.2026
File	Artur 44.dwg	Drawn by	

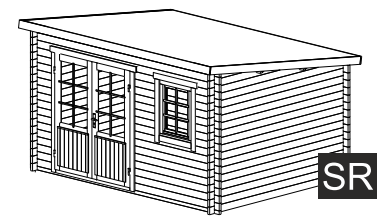
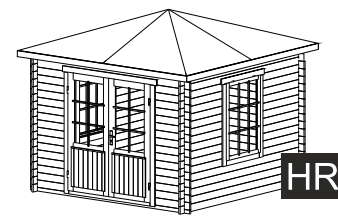
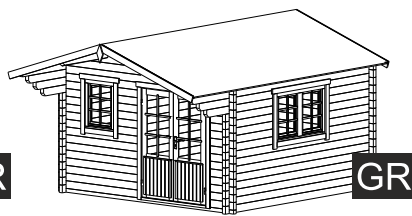
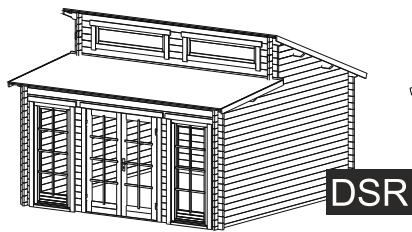
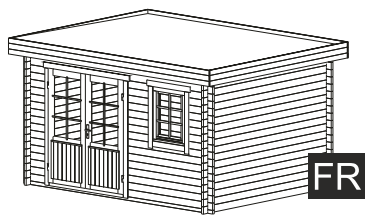

FR

DSR

GR

HR

SR

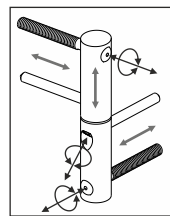
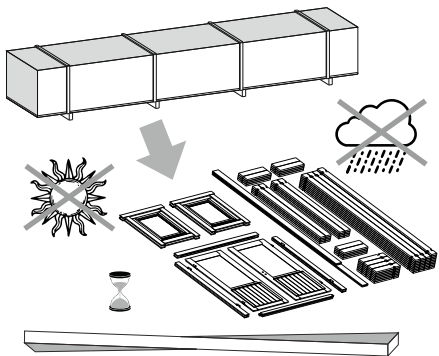

ADJUSTABLE HINGES

3.

TYPE- A  
5x90

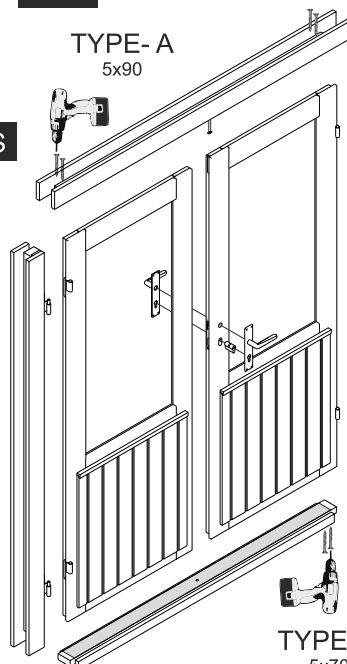

OPTIONS

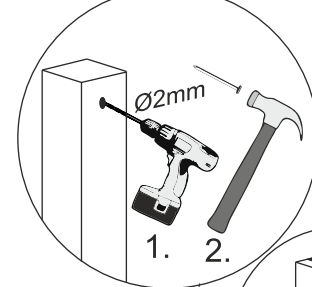

1. 2.

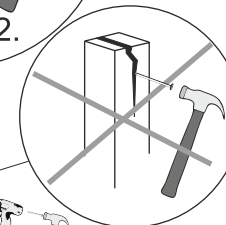

4.

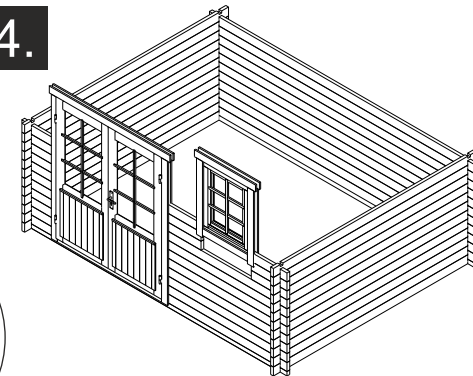

1.

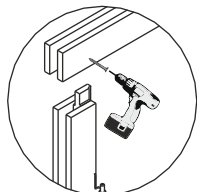
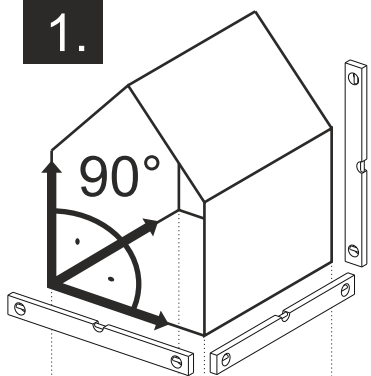

TYPE- B  
4x60

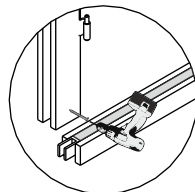

5.

OPTIONS

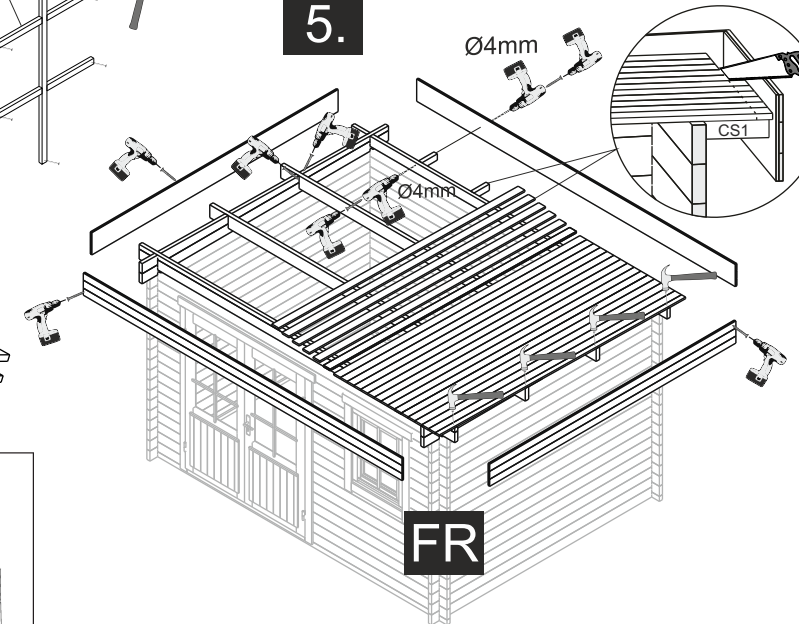

Ø4mm

FR

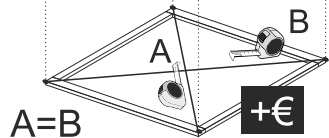

+€

NB!

TYPE- A  
5x70

OPTIONS

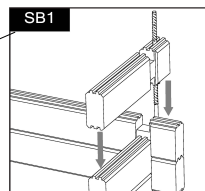

2.

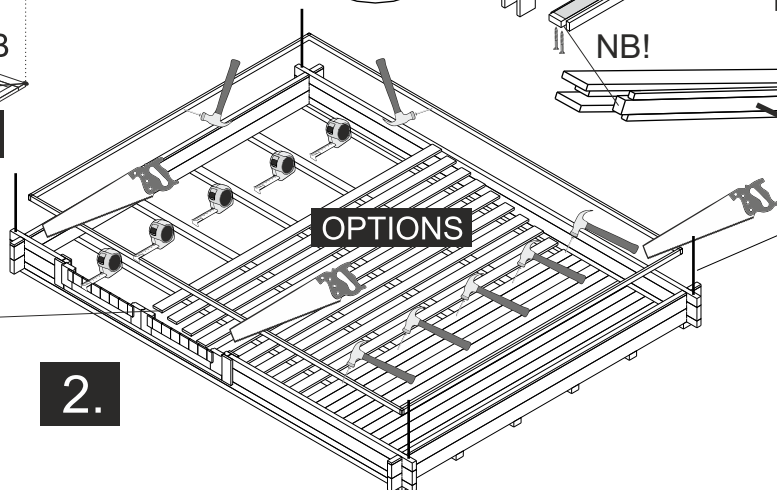

OPTIONS

The guide is illustrative. This guide is not project specification.  
Der Leitfaden ist illustrativ. Dieser Leitfaden ist keine Projektspezifikation.  
De gids is illustratief. Deze gids is geen projectspecificatie.

5.

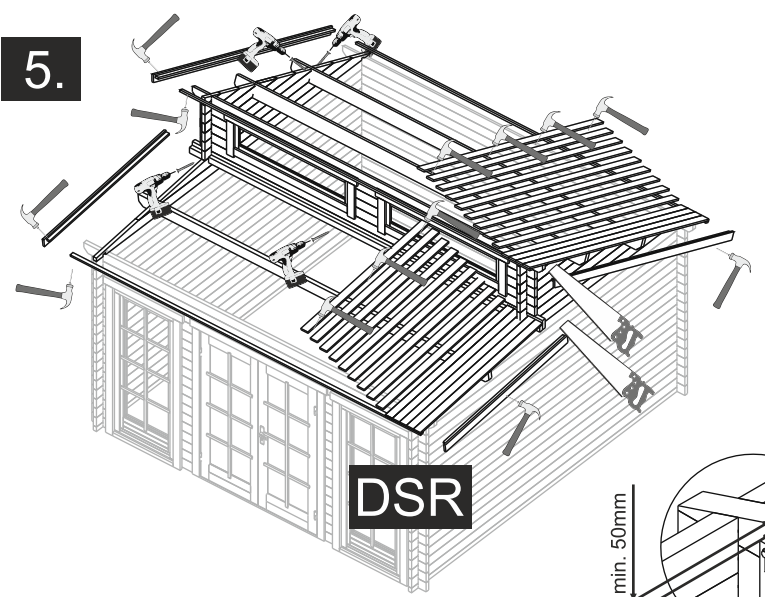

5.

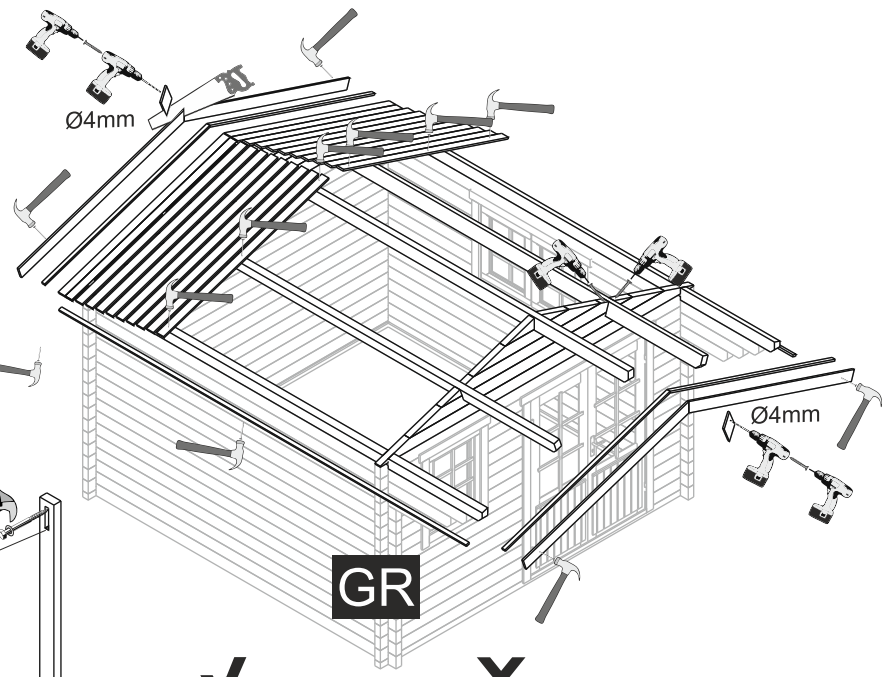

OPTIONS

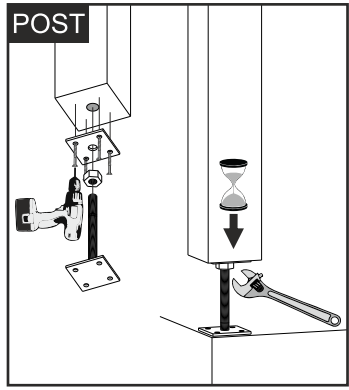
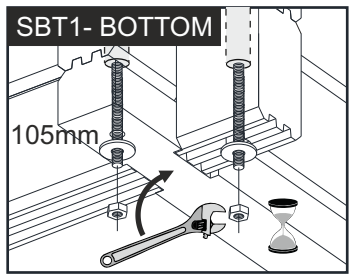
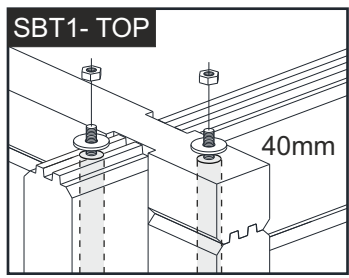
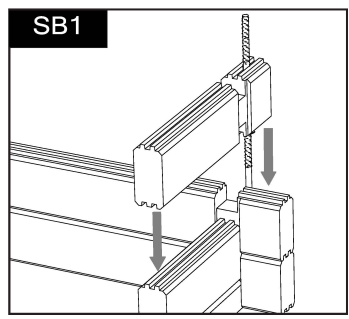

NB!

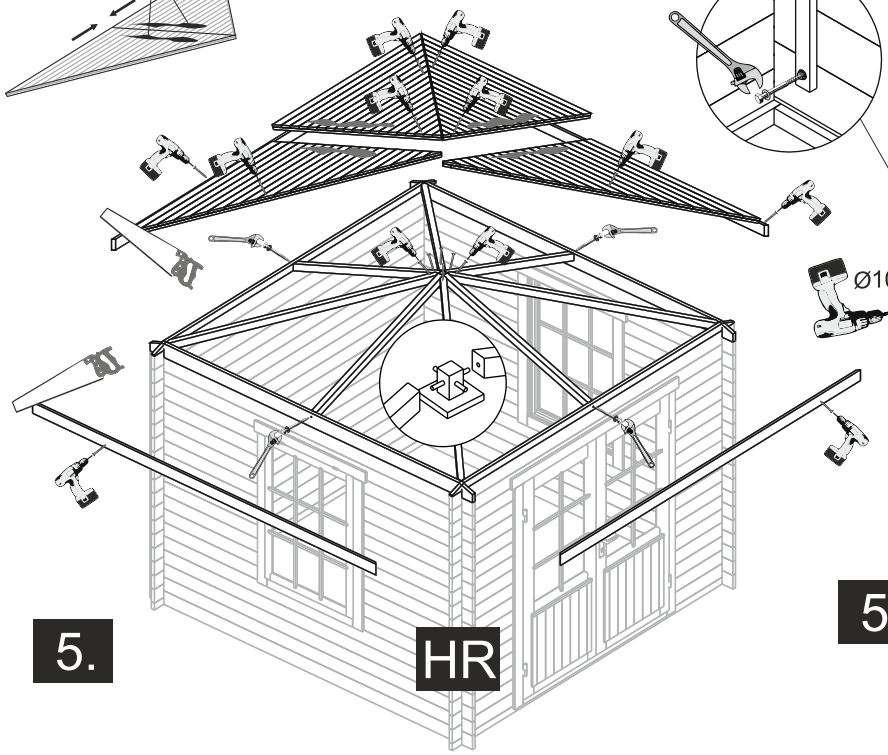

5.

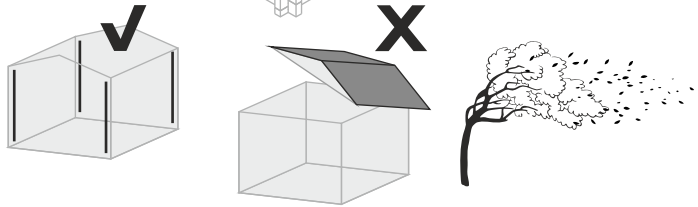

OPTIONS-STORM BRACES

5.

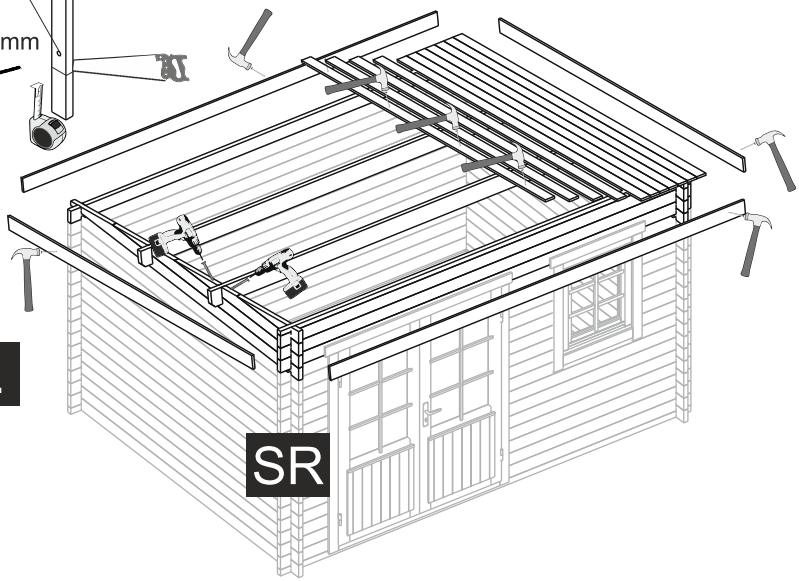

SR

Öffnung/Opening

A

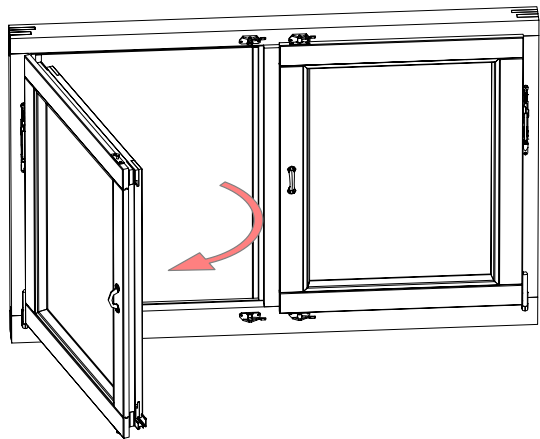
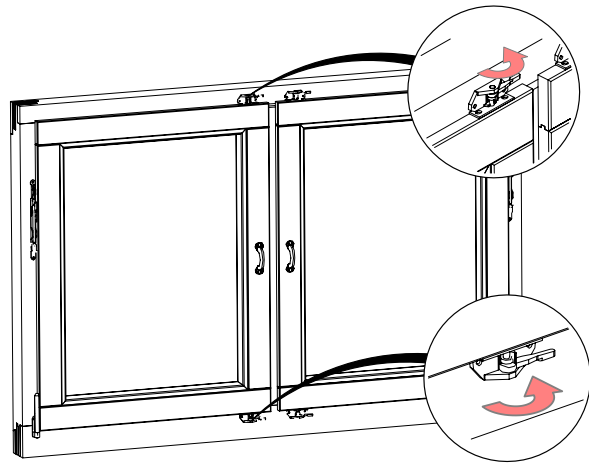

B

